

R&S® ZNBT VECTOR NETWORK ANALYZER



Network analysis with up to 24 test ports



Product Brochure
Version 07.00

ROHDE & SCHWARZ

Make ideas real



AT A GLANCE

The R&S®ZNB8 is the first multiport vector network analyzer offering up to 24 integrated test ports. The instrument can simultaneously test multiple DUTs or measure one DUT with up to 24 ports.

The R&S®ZNB8 offers short measurement times even in scenarios with a large number of ports. Other highlights include a wide dynamic range, high output power levels and inputs featuring high power-handling capacity.

The instrument operates in four different frequency ranges:

- ▶ R&S®ZNB8 from 9 kHz to 8.5 GHz
- ▶ R&S®ZNB20 from 100 kHz to 20 GHz
- ▶ R&S®ZNB26 from 100 kHz to 26.5 GHz
- ▶ R&S®ZNB40 from 100 kHz to 40 GHz

These features make the R&S®ZNB8 ideal for applications in the mobile radio, wireless communications and electronic goods industries.

The instrument is successfully used in the development and production of active and passive multiport components and frontend modules for mobile communications devices such as smart phones. Its outstanding performance also allows efficient analysis of base station filters and other highly selective components.

Thanks to its high frequency range and high number of testports, the R&S®ZNB8 provides easy and high speed measurements for signal integrity as well as multi-array antenna measurement applications such as 5G antenna systems.

The R&S®ZNB8 outperforms switch matrix based multiport systems. Its high integration density makes it a very compact solution for analyzing components with up to 24 ports while requiring no more rack space than an R&S®ZNB.

The convenient user interface makes it easy to handle even very complex multiport measurements. The R&S®ZNB8 supports various remote control options and is easy to integrate into automated test systems, for example for carrying out phased-array antenna measurements.

R&S®ZNB8 with 24 ports

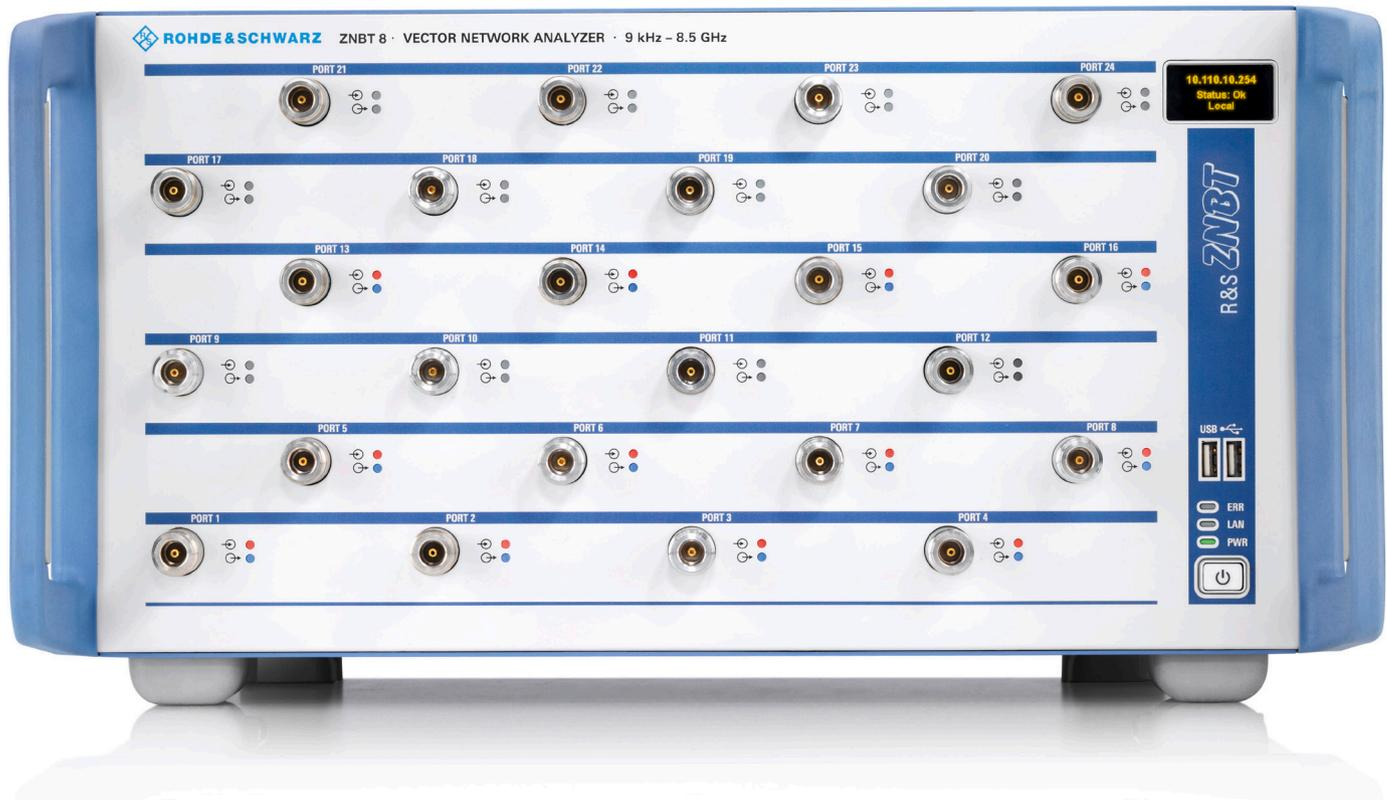

KEY FACTS

- ▶ Four-port R&S®ZNB8 base unit, upgradeable to 8, 12, 16, 20 or 24 ports
- ▶ Eight-port R&S®ZNB20, R&S®ZNB26 or R&S®ZNB40 base unit, upgradeable to 12, 16, 20 or 24 ports
- ▶ Frequency range from 9 kHz to 8.5 GHz (R&S®ZNB8), from 100 kHz to 20 GHz (R&S®ZNB20), to 26.5 GHz (R&S®ZNB26) and to 40 GHz (R&S®ZNB40)
- ▶ Up to 24 fully phase-coherent receivers
- ▶ Wide dynamic range of up to 140 dB
- ▶ Short sweep times, e.g. 1.7 ms (R&S®ZNB8) and 2.7 ms (R&S®ZNB20, R&S®ZNB26, R&S®ZNB40) for a sweep across 201 points
- ▶ Wide power sweep range of up to 100 dB
- ▶ High power-handling capacity
- ▶ IF bandwidths from 1 Hz to 10 MHz
- ▶ High temperature stability of 0.01 dB/°K
- ▶ More than 100 traces and channels
- ▶ Simple configuration of multiport measurements
- ▶ Manual and automatic calibration methods optimized for multiport applications
- ▶ Status information
- ▶ Compatible with all vector network analyzers from the R&S®ZVA/R&S®ZVT and R&S®ZNx families

R&S®ZNB20 with 24 ports

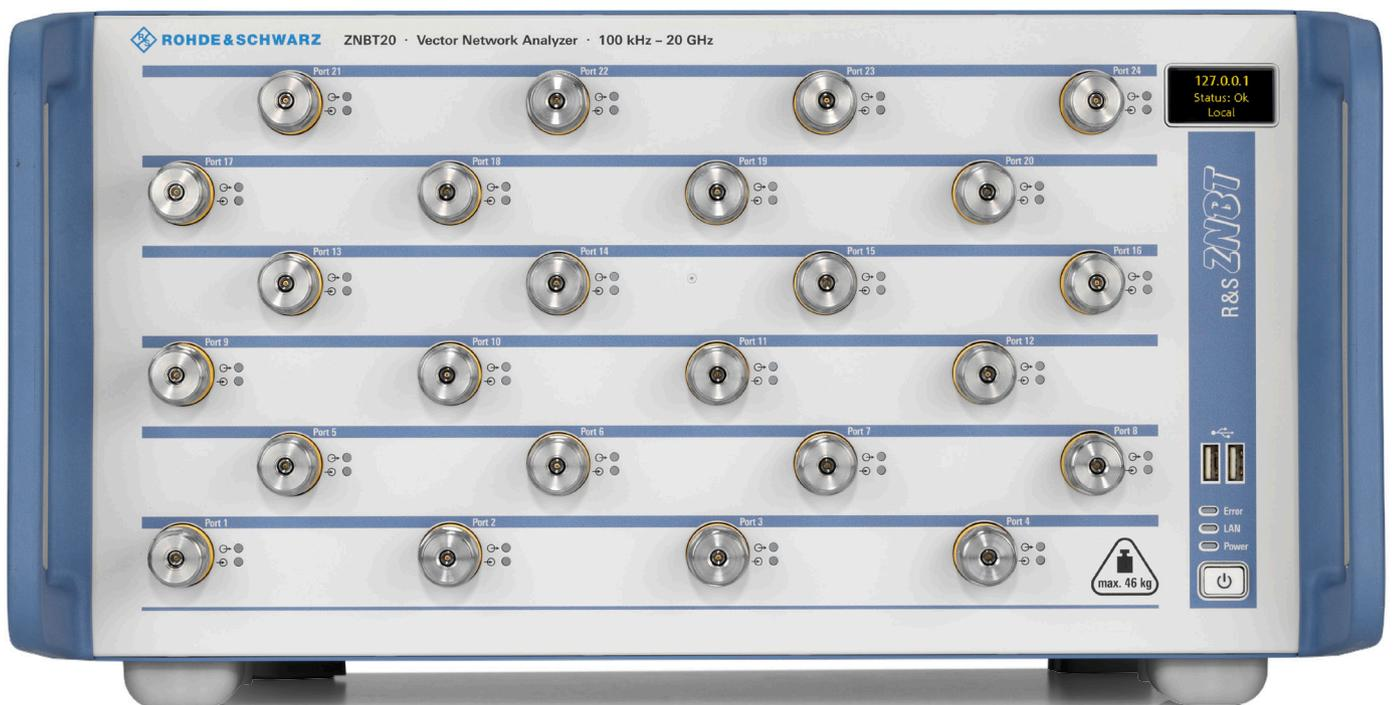

BENEFITS AND KEY FEATURES

Platform for demanding multiport measurements

- ▶ True multiport network analyzer
- ▶ Multiport measurements made easy
- ▶ Measurements at high power levels
- ▶ [page 5](#)

When speed counts

- ▶ Short test times even with a large number of ports
- ▶ Data transfer simultaneously with sweep
- ▶ Fast switchover between instrument setups
- ▶ Test sequence control via TTL signals
- ▶ Handler I/O interface for control of external parts handlers
- ▶ Simultaneous testing of multiple DUTs
- ▶ Segmented sweep for optimized speed and accuracy
- ▶ Extended dynamic range for fast measurements on high-blocking filters
- ▶ [page 6](#)

Complex analysis of active and passive components

- ▶ More than 100 traces and channels for characterizing complex components
- ▶ Wide range of virtual matching networks for realtime embedding/deembedding
- ▶ Frequency-converting measurements on amplifiers and mixers
- ▶ Simple and fast characterization of balanced DUTs
- ▶ Time domain analysis with gating function and display of eye diagrams
- ▶ Voltage and current measurements
- ▶ Measurements on frontend modules (FEM)
- ▶ [page 8](#)

Excellent measurement characteristics

- ▶ Fast and accurate
- ▶ High long-term stability for long calibration intervals
- ▶ Calibration methods for every application
- ▶ Calibration units speed up multiport calibrations
- ▶ [page 11](#)

The R&S®ZNB can be operated manually using a keyboard, mouse and external monitor, or via an external touchscreen.



PLATFORM FOR DEMANDING MULTIPOINT MEASUREMENTS

True multipoint network analyzer

The R&S®ZNBT is a true multipoint network analyzer featuring one reflectometer per test port. This design concept does away with the loss between the test ports and the measurement receivers and the instability typically encountered in switch matrix based multipoint systems. As a result, the R&S®ZNBT delivers a wide dynamic range, high output power, low trace noise, and excellent raw directivity and load match. Multipoint measurements with the R&S®ZNBT are thus highly stable, reproducible and precise. The analyzer's architecture is tailored for parallel signal and data acquisition. This means that the R&S®ZNBT not only measures S-parameters of multipoint DUTs, but also performs phase-synchronous measurements of up to 24 signals. Thanks to the analyzer's modular design, the four-port R&S®ZNBT8 base unit can easily be upgraded to an instrument with 8, 12, 16, 20 or 24 ports, and the eight-port R&S®ZNBT20, R&S®ZNBT26 and R&S®ZNBT40 base units can be upgraded to include 12, 16, 20 or 24 ports.

Block diagram of an R&S®ZNBT

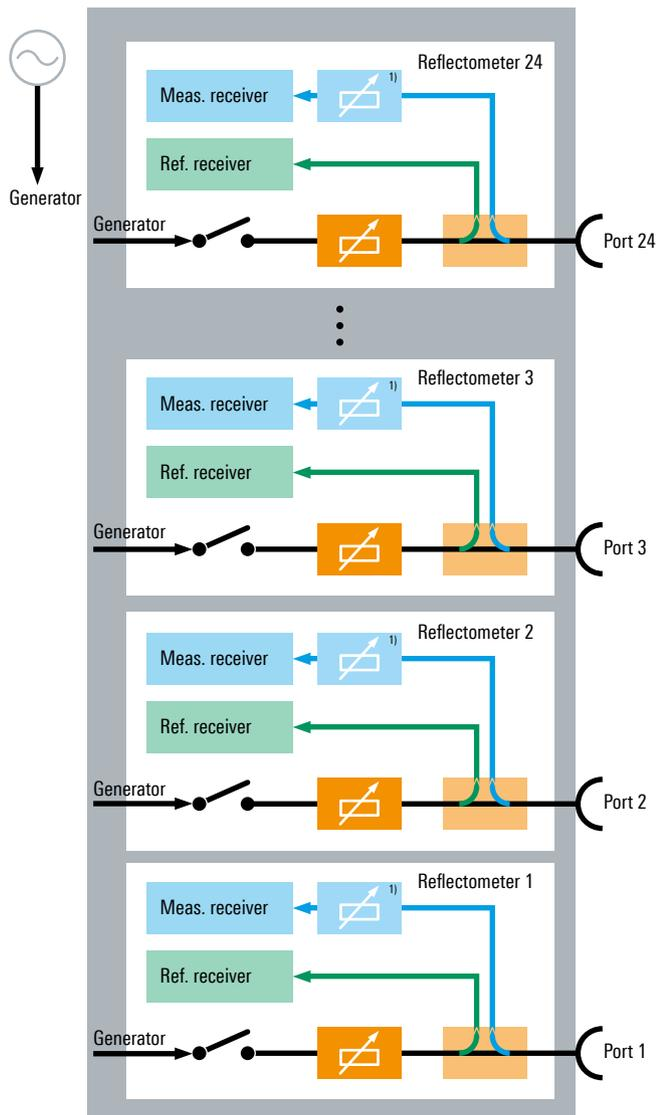

Multipoint measurements made easy

The R&S®ZNBT is controlled via the same user interface as the R&S®ZNB. As an instrument without integrated display, it can be operated via a keyboard, mouse and external monitor, or via an external touchscreen. The instrument's software architecture is designed with a consistent focus on multipoint applications. Measurements are directly selected via the user interface, including S-parameters, wave quantities and wave ratios. Test port indices can be entered directly for S-parameters and power levels. Each measurement can be selected with a maximum of three operating steps, even when testing DUTs with a large number of ports. The R&S®ZNBT can be remotely controlled via a remote desktop connection and SCPI commands.

Measurements at high power levels

The R&S®ZNBT characterizes the small-signal behavior at low power levels and measures nonlinear parameters at high power levels. The electronically variable power range delivers typical output power levels from -85 dBm to +15 dBm for the R&S®ZNBT8, from -60 dBm to +12 dBm for the R&S®ZNBT20 and from -60 dBm to +8 dBm for the R&S®ZNBT26/R&S®ZNBT40. Electronic step attenuators¹⁾ increase the measurement receivers' power handling capacity even further. The electronic step attenuators have a high compression point, eliminating the need for additional attenuators at high power levels.

¹⁾ For R&S®ZNBT8 only.

WHEN SPEED COUNTS

Short test times even with a large number of ports

Featuring large IF bandwidths, short sampling times and fast synthesizers with short frequency switching times, the R&S®ZNBТ measures 24 one-port DUTs in only 1.9 ms (R&S®ZNBТ8) and 2.7 ms (R&S®ZNBТ20, R&S®ZNBТ26, R&S®ZNBТ40), both in a single frequency sweep over 201 points²⁾.

The instrument's multiport architecture makes it possible to perform simultaneous measurements on all ports of a DUT. Data from all ports is captured synchronously and processed in parallel – from the RF test port through the IF stage to the display. This means a significant reduction in sweep time compared to switch matrix based multiport systems.

Data transfer simultaneously with sweep

The R&S®ZNBТ allows measurement data to be read out via LAN or GPIB while the next sweep is already in progress. The data transfer time is therefore practically negligible and does not increase the sweep time.

²⁾ R&S®ZNBТ8: 800 MHz start frequency, 1 GHz stop frequency, AGC auto, 500 kHz measurement bandwidth, swept mode, correction off. R&S®ZNBТ20, R&S®ZNBТ26, R&S®ZNBТ40: 9 GHz start frequency, 10 GHz stop frequency, AGC auto, 500 kHz measurement bandwidth, swept mode, correction off.

Fast switchover between instrument setups

In complex scenarios involving measurements on DUTs using different analyzer setups, the R&S®ZNBТ does not waste time reloading the required setups from the hard disk. Once a setup has been loaded from the hard disk, it remains stored in the instrument's RAM along with the computed data for the test sequence to be executed. This allows activation of instrument setups via remote control virtually without delay.

Test sequence control via TTL signals

Various digital interfaces are available to boost the speed of automatic test cycles. For example, the user control port has special outputs that can be assigned different bit combinations (referred to as channel bits) that will be used for the currently active measurement channel. The channel bits are used to synchronize external components in a test setup or the settings of a DUT to the analyzer's internal test sequences in realtime.

Handler I/O interface for control of external parts handlers

Via the optional external handler I/O interface, the R&S®ZNBТ can communicate with an external parts handler. During a typical test cycle, a parts handler places the DUT into a holder and sends the start signal for the measurement. On completion of the measurement, the parts handler removes the DUT from the holder and sorts

Comparison of measurement time: the R&S®ZNBТ versus switch matrix based multiport solutions

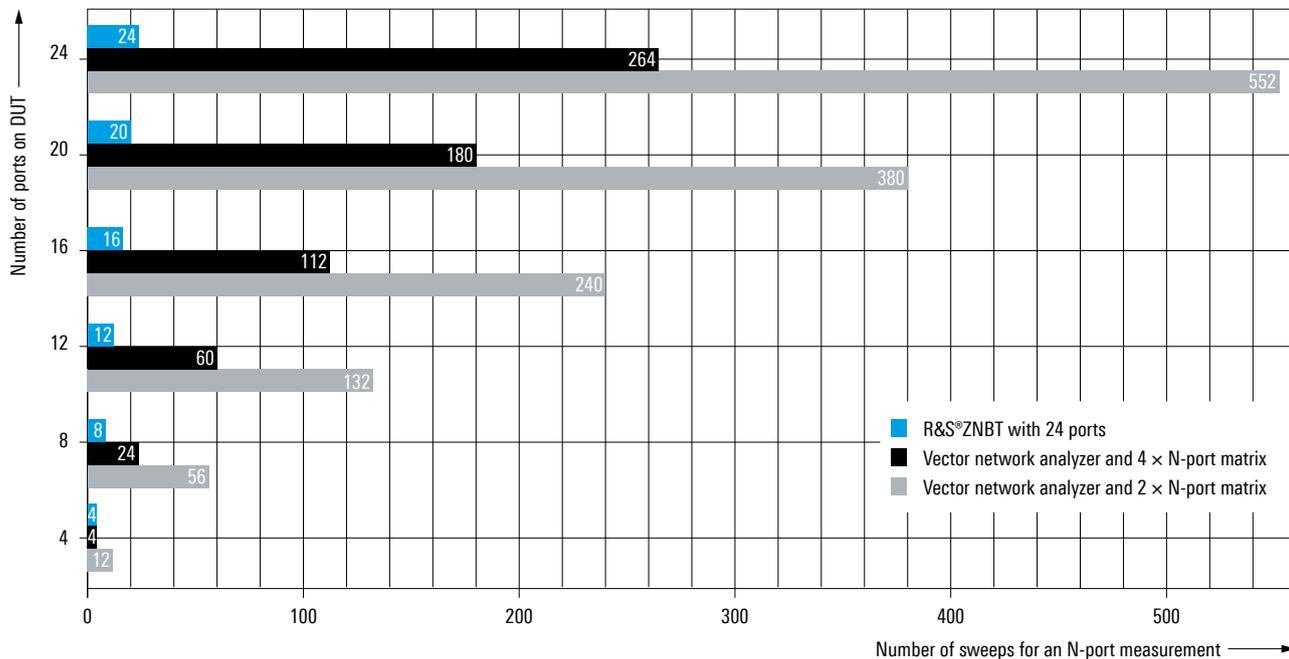

it according to predefined criteria. Then the handler places a new DUT in the holder, and the test cycle starts again. The R&S®ZNBT can thus be used to deliver fast, reliable results in automated tests, which play a key role especially in production applications.

Simultaneous testing of multiple DUTs

The architecture of the R&S®ZNBT allows stimulating multiple DUT ports simultaneously, making it possible to test multiple paths of one DUT or multiple DUTs in parallel. The R&S®ZNBT organizes its test ports into groups, where test sequences for all groups are executed in parallel. A 24-port R&S®ZNBT, for example, can simultaneously test six DUTs with four ports each.

Segmented sweep for optimized speed and accuracy

Testing frequency-selective DUTs such as filters in front-end modules requires optimized output power levels in the passband to avoid errors due to compression. In the

Parallel testing of two DUTs

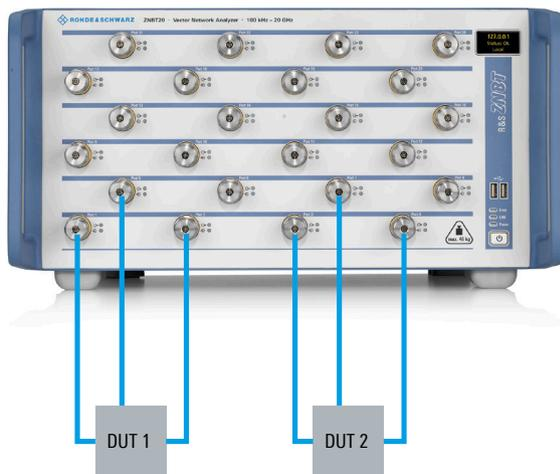

stopband, on the other hand, high output power levels and narrow IF bandwidths are needed to provide the required dynamic range. The instrument's segmented sweep function allows the sweep range to be divided into an almost unlimited number of segments. Sweep parameters such as test point spacing, IF bandwidth and generator power can be defined separately for each segment and accurately matched to the task at hand, optimizing measurement speed and accuracy.

Extended dynamic range for fast measurements on high-blocking filters

The R&S®ZNBT receivers combine high power-handling capacity with high sensitivity and low trace noise. The R&S®ZNBT8 provides industry-leading 140 dB typical dynamic range at 10 Hz IF bandwidth. The R&S®ZNBT8-B5xx options further extend the dynamic range for individual port groups up to 145 dB. This mainly speeds up manual adjustments on high-blocking filters for larger IF bandwidth settings on the R&S®ZNBT. The R&S®ZNBT8-B5xx options lead to reduced output power and a slightly degraded port match. They can be combined with the R&S®ZNBT8-B1xx port extension options (additional ports) as necessary to match the requirements for a given application. They cannot be combined with the R&S®ZNBT8-B3xx options.

Filter measurement using segmented sweep

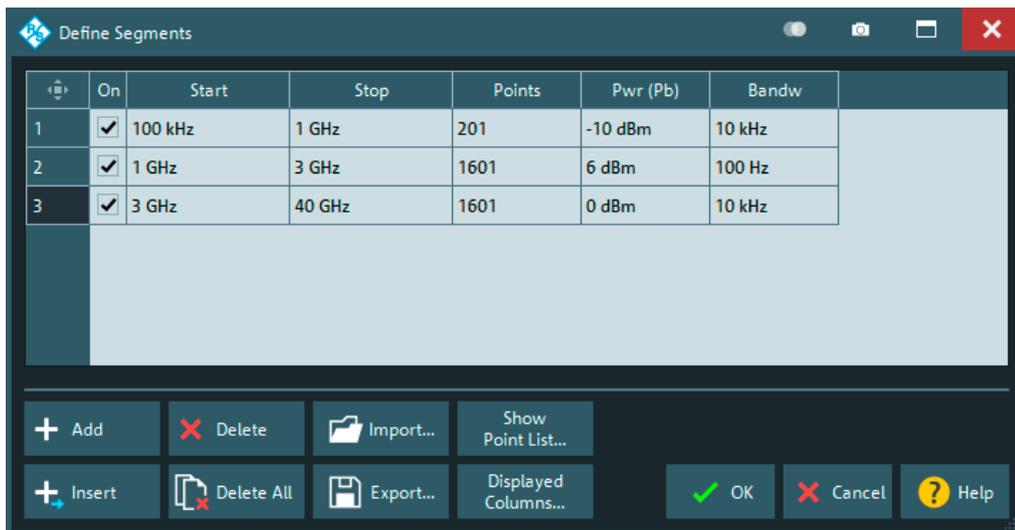

COMPLEX ANALYSIS OF ACTIVE AND PASSIVE COMPONENTS

The demand for modules offering enhanced performance with ever smaller dimensions is driving the trend toward higher levels of integration and functional density in modern RF modules, especially for mobile radio and WLAN applications. These modules require complex testing of their small-signal and large-signal behavior during production. The R&S®ZNB T performs these tests with high speed and accuracy.

More than 100 traces and channels for characterizing complex components

The R&S®ZNB T supports a virtually unlimited number of traces and channels in order to execute and display complex measurements on multiport DUTs. The number of traces and channels is limited only by the instrument's RAM. By successively processing several different channels, the R&S®ZNB T characterizes a DUT under different conditions. For example, the instrument can test an amplifier on different port groups while applying different supply voltages and RF input power levels, and display all of the parameters measured – wasting no time on loading new setups. The names of traces and channels can be edited and replaced by user-specific names to make them easier to identify.

Wide range of virtual matching networks for realtime embedding/deembedding

Balanced and unbalanced components are often specified together with the networks that match them to the impedance of the surrounding circuit.

The R&S®ZNB T offers a wide range of predefined, editable matching network topologies. Using special algorithms, the R&S®ZNB T embeds the DUT into such networks, or deembeds it to eliminate parasitic effects caused by test fixtures, for example. Alternatively, user-defined networks can be imported in .SNP file format.

Mixer setup menu for the R&S®ZNB T

The screenshot displays the 'Mixer' setup menu. At the top, there's a 'Setup' window with a dropdown menu set to 'Ch_M'. Below this is a block diagram showing a mixer (Mixer 1) with three ports: Port 1 (RF), Port 2 (IF), and Port 3 (LO). Port 1 is set to 1 GHz...4.3 GHz, 0 dBm. Port 2 is set to 100 kHz, 0 dBm. Port 3 is set to 1.0001 GHz...4.3001 GHz, 7 dBm. Below the diagram is a table with columns for Frequency, Power, and Multiplication. The table has three rows: Base Freq (RF), Fixed (IF), and Auto (LO). Below the table is a 'Conversion' dropdown menu set to 'IF = LO - RF (LSB)'. At the bottom, there are buttons for 'Reset', 'Generators', 'Copy To New CH + Diagram', 'Copy To New Channel', 'OK', 'Cancel', and 'Help'.

Frequency	Power	Multiplication	
Type	Port	Start/CW	
Base Freq	RF	1 GHz	4.3 GHz
Fixed	IF	100 kHz	
Auto	LO	1.0001 GHz	4.3001 GHz

Frequency-converting measurements on amplifiers and mixers

The R&S®ZNBT features independent synthesizers for its generators and receivers, enabling it to transmit and receive on different frequencies. This allows the R&S®ZNBT to measure harmonics and intermodulation products on amplifiers, or conversion loss on mixers. External generators may sometimes be needed to generate a multitone signal or provide local oscillator functionality. The R&S®ZNBT can control generators from Rohde&Schwarz or other suppliers via LAN or GPIB. Wizards for intermodulation and mixer measurements guide the user step by step to the desired test setup and through calibration, saving time and ensuring correct results.

Simple and fast characterization of balanced DUTs

To characterize a balanced DUT, the R&S®ZNBT measures its unbalanced S-parameters and uses them to calculate the mixed-mode S-parameters. The S-parameter wizard assists the user in choosing the port topology, the S-parameters to be displayed and the appropriate calibration method.

Time domain analysis with gating function and display of eye diagrams

Using the time domain analysis option, users can analyze discontinuities in test fixtures and cables or the triple transit echo in SAW filters and use gating to eliminate such unwanted effects. The extended time domain analysis option makes it possible to display eye diagrams for different bit patterns simultaneously with measurements in the frequency and time domain.

Voltage and current measurements

In addition to the RF test ports, the instrument has four DC test inputs on its rear panel for measuring DC supply voltages or voltages proportional to supply currents during frequency and power sweeps. These measurements are performed synchronously with the sweep and can be used to determine power added efficiency (PAE) or measure the characteristics of power detectors.

Simultaneous display of eye diagrams and measurements in the frequency and time domain.



Measurements on frontend modules (FEM)

The lower figure shows a typical measurement performed with the R&S®ZNB between the RF ports of a frontend module. The instrument's first DC input is used to determine the supply current to the amplifier versus frequency and level. The second DC input is used to measure the power detector characteristic versus frequency and level.

Channel bits from the analyzer's user control port are used to control the DUT's switch in order to select the required measurement paths. The TX → Ant and RX → Ant paths are measured in parallel, i.e. simultaneously, using testport groups. This cuts the sweep time in half without any loss of performance.

Testing a frontend module

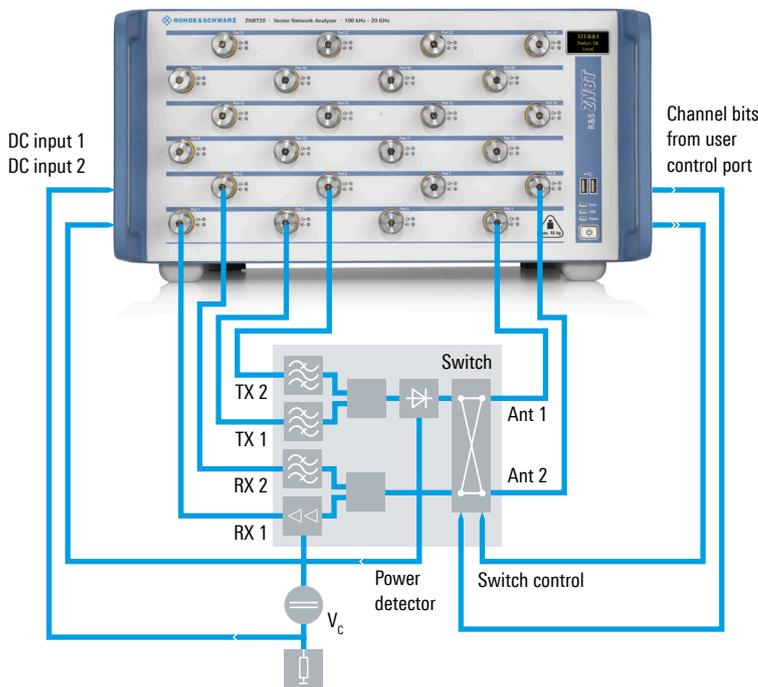

Key features

Amplifier and mixer measurements

- ▶ High output power on all ports
 - up to +15 dBm for the R&S®ZNB8
 - up to +12 dBm for the R&S®ZNB20
 - up to +8 dBm for the R&S®ZNB26/R&S®ZNB40
- ▶ Large power sweep range
 - up to 98 dB for the R&S®ZNB8
 - up to 72 dB for the R&S®ZNB20
 - up to 68 dB for the R&S®ZNB26/R&S®ZNB40
- ▶ Intermodulation, harmonics and compression measurements
- ▶ Absolute power measurements
- ▶ Four DC inputs for measuring supply voltages and power detector characteristics
- ▶ Power added efficiency (PAE) measurements
- ▶ Measurement of stability factors
- ▶ Determination of Y- and Z-parameters
- ▶ Conversion loss measurements

Filter measurements

- ▶ Wide dynamic range
 - up to 140 dB for the R&S®ZNB8/R&S®ZNB20
 - up to 135 dB for the R&S®ZNB26/R&S®ZNB40
- ▶ Display of filter parameters, e.g. center frequency, bandwidth, quality factor
- ▶ Determination of mixed-mode S-parameters of balanced DUTs
- ▶ Virtual matching networks for realtime embedding/deembedding of balanced and unbalanced DUTs, including embedding/deembedding of port pairs and ground loop inductance
- ▶ Impedance conversion
- ▶ Time domain analysis with gating function, e.g. for suppressing triple transit echo in SAW filters, and display of eye diagrams

EXCELLENT MEASUREMENT CHARACTERISTICS

Fast and accurate

Offering up to 140 dB dynamic range, the R&S®ZNB1 is ideal for the fast characterization of frequency-selective multiport components. The R&S®ZNB1 features a dynamic range higher than that of conventional multiport solutions. This means that, for the same dynamic range, the R&S®ZNB1 can use a larger IF bandwidth and measure faster than conventional setups.

Due to the instrument's sensitive receivers, trace noise is negligible even when using large IF bandwidths.

High long-term stability for long calibration intervals

The instrument's excellent raw performance (directivity, load match and tracking) ensures good long-term thermal stability as well as high measurement accuracy after calibration. The R&S®ZNB1 delivers stable results over several days without requiring recalibration.

Calibration methods for every application

The R&S®ZNB1 supports diverse calibration methods for coaxial applications, for testing DUTs in test fixtures and on printed boards, and for on-wafer applications.

- ▶ **TOSM (Through, Open, Short, Match):** classic calibration method for coaxial test environments
- ▶ **TSM (Through, Short, Match):** full two-port calibration method requiring less calibration effort
- ▶ **TRL/LRL (Through, Reflect, Line/Line, Reflect, Line):** calibration method for printed board based test structures and on-wafer applications

- ▶ **TRM/TNA (Through, Reflect, Match/Through, Network, Attenuation):** calibration method for applications using test fixtures
- ▶ **UOSM (Unknown Through, Open, Short, Match):** calibration method for DUTs using a mix of connectors

The above calibration methods have been optimized for multiport applications so that the through standard needs to be connected only a minimum number of times. The TSM method considerably reduces calibration time as it requires no open standard. TSM provides accuracy equivalent to that of TOSM and reduces the number of calibration standards to be connected to each port from four to three.

Calibration units speed up multiport calibrations

In coaxial multiport applications, it is advisable to use automatic calibration units in order to minimize the number of required connections and avoid lengthy calibration times as well as premature wear on ports and calibration standards. Rohde & Schwarz offers calibration units with up to 24 ports. Applications involving a large number of ports can be calibrated using a calibration unit with a lower number of ports and connecting it sequentially to the test ports in question. A software wizard guides the user step by step through the calibration.

R&S®ZN-Z151, R&S®ZN-Z152 and R&S®ZN-Z153 calibration units



R&S®ZN-Z54 calibration unit



R&S®ZN-Z154 calibration unit

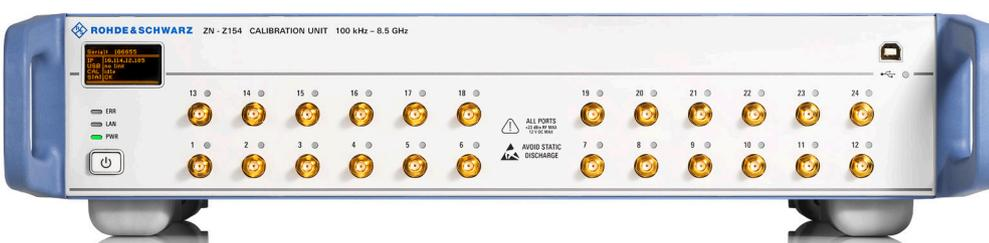

ORDERING INFORMATION

Designation	Type	Frequency range	Order No.
Base unit			
Vector network analyzer, 4 ports, 8.5 GHz, N ¹⁾	R&S®ZNB8	9 kHz to 8.5 GHz	1318.7006.24
Vector network analyzer, 8 ports, 20 GHz, 3.5 mm ¹⁾	R&S®ZNB20	100 kHz to 20 GHz	1332.9002.24
Vector network analyzer, 8 ports, 26.5 GHz, 2.92 mm ¹⁾	R&S®ZNB26	100 kHz to 26.5 GHz	1332.9002.34
Vector network analyzer, 8 ports, 40 GHz, 2.92 mm ¹⁾	R&S®ZNB40	100 kHz to 40 GHz	1332.9002.44
Hardware options			
Additional ports 5 to 8 for the R&S®ZNB8	R&S®ZNB8-B108	9 kHz to 8.5 GHz	1319.4200.02
Additional ports 9 to 12 for the R&S®ZNB8 (requires ports 5 to 8)	R&S®ZNB8-B112	9 kHz to 8.5 GHz	1319.4217.02
Additional ports 13 to 16 for the R&S®ZNB8 (requires ports 5 to 12)	R&S®ZNB8-B116	9 kHz to 8.5 GHz	1319.4223.02
Additional ports 17 to 20 for the R&S®ZNB8 (requires ports 5 to 16)	R&S®ZNB8-B120	9 kHz to 8.5 GHz	1319.4230.02
Additional ports 21 to 24 for the R&S®ZNB8 (requires ports 5 to 20)	R&S®ZNB8-B124	9 kHz to 8.5 GHz	1319.4246.02
Additional ports 9 to 12 for the R&S®ZNB20	R&S®ZNB20B112	100 kHz to 20 GHz	1332.9454.02
Additional ports 13 to 16 for the R&S®ZNB20 (requires ports 9 to 12)	R&S®ZNB20B116	100 kHz to 20 GHz	1332.9460.02
Additional ports 17 to 20 for the R&S®ZNB20 (requires ports 9 to 16)	R&S®ZNB20B120	100 kHz to 20 GHz	1332.9302.02
Additional ports 21 to 24 for the R&S®ZNB20 (requires ports 9 to 20)	R&S®ZNB20B124	100 kHz to 20 GHz	1332.9319.02
Additional ports 9 to 12 for the R&S®ZNB26	R&S®ZNB26B112	100 kHz to 26.5 GHz	1332.9454.34
Additional ports 13 to 16 for the R&S®ZNB26 (requires ports 9 to 12)	R&S®ZNB26B116	100 kHz to 26.5 GHz	1332.9460.34
Additional ports 17 to 20 for the R&S®ZNB26 (requires ports 9 to 16)	R&S®ZNB26B120	100 kHz to 26.5 GHz	1332.9302.34
Additional ports 21 to 24 for the R&S®ZNB26 (requires ports 9 to 20)	R&S®ZNB26B124	100 kHz to 26.5 GHz	1332.9319.34
Additional ports 9 to 12 for the R&S®ZNB40	R&S®ZNB40B112	100 kHz to 40 GHz	1332.9454.44
Additional ports 13 to 16 for the R&S®ZNB40 (requires ports 9 to 12)	R&S®ZNB40B116	100 kHz to 40 GHz	1332.9460.44
Additional ports 17 to 20 for the R&S®ZNB40 (requires ports 9 to 16)	R&S®ZNB40B120	100 kHz to 40 GHz	1332.9302.44
Additional ports 21 to 24 for the R&S®ZNB40 (requires ports 9 to 20)	R&S®ZNB40B124	100 kHz to 40 GHz	1332.9319.44
Receiver step attenuators for ports 1 to 4 ²⁾	R&S®ZNB8-B361	9 kHz to 8.5 GHz	1319.4317.02
Receiver step attenuators for ports 5 to 8 ^{2) 3)}	R&S®ZNB8-B362	9 kHz to 8.5 GHz	1319.4323.02
Receiver step attenuators for ports 9 to 12 ^{2) 3)}	R&S®ZNB8-B363	9 kHz to 8.5 GHz	1319.4330.02
Receiver step attenuators for ports 13 to 16 ^{2) 3)}	R&S®ZNB8-B364	9 kHz to 8.5 GHz	1319.4346.02
Receiver step attenuators for ports 17 to 20 ^{2) 3)}	R&S®ZNB8-B365	9 kHz to 8.5 GHz	1319.4352.02
Receiver step attenuators for ports 21 to 24 ^{2) 3)}	R&S®ZNB8-B366	9 kHz to 8.5 GHz	1319.4369.02
Extended dynamic range for ports 1 to 4 ^{2) 5) 6)}	R&S®ZNB8-B504	9 kHz to 8.5 GHz	1332.8335.02
Extended dynamic range including ports 5 to 8 ^{2) 6) 7)}	R&S®ZNB8-B508	9 kHz to 8.5 GHz	1332.8341.02
Extended dynamic range including ports 9 to 12 ^{2) 6) 7)}	R&S®ZNB8-B512	9 kHz to 8.5 GHz	1332.8358.02
Extended dynamic range including ports 13 to 16 ^{2) 6) 7)}	R&S®ZNB8-B516	9 kHz to 8.5 GHz	1332.8364.02
Extended dynamic range including ports 17 to 20 ^{2) 6) 7)}	R&S®ZNB8-B520	9 kHz to 8.5 GHz	1332.8370.02
Extended dynamic range including ports 21 to 24 ^{2) 6) 7)}	R&S®ZNB8-B524	9 kHz to 8.5 GHz	1332.8387.02
Extended power range for ports 1 to 4 (R&S®ZNB8)	R&S®ZNB8-B21	9 kHz to 8.5 GHz	1319.4252.02
Extended power range for ports 5 to 8 (R&S®ZNB8) ⁴⁾	R&S®ZNB8-B22	9 kHz to 8.5 GHz	1319.4269.02
Extended power range for ports 9 to 12 (R&S®ZNB8) ⁴⁾	R&S®ZNB8-B23	9 kHz to 8.5 GHz	1319.4275.02
Extended power range for ports 13 to 16 (R&S®ZNB8) ⁴⁾	R&S®ZNB8-B24	9 kHz to 8.5 GHz	1319.4281.02
Extended power range for ports 17 to 20 (R&S®ZNB8) ⁴⁾	R&S®ZNB8-B25	9 kHz to 8.5 GHz	1319.4298.02
Extended power range for ports 21 to 24 (R&S®ZNB8) ⁴⁾	R&S®ZNB8-B26	9 kHz to 8.5 GHz	1319.4300.02
Extended power range for ports 1 to 4 (R&S®ZNB20)	R&S®ZNB20-B21	100 kHz to 20 GHz	1332.9348.02
Extended power range for ports 5 to 8 (R&S®ZNB20)	R&S®ZNB20-B22	100 kHz to 20 GHz	1332.9354.02
Extended power range for ports 9 to 12 (R&S®ZNB20) ⁴⁾	R&S®ZNB20-B23	100 kHz to 20 GHz	1332.9360.02
Extended power range for ports 13 to 16 (R&S®ZNB20) ⁴⁾	R&S®ZNB20-B24	100 kHz to 20 GHz	1332.9377.02
Extended power range for ports 17 to 20 (R&S®ZNB20) ⁴⁾	R&S®ZNB20-B25	100 kHz to 20 GHz	1332.9383.02
Extended power range for ports 21 to 24 (R&S®ZNB20) ⁴⁾	R&S®ZNB20-B26	100 kHz to 20 GHz	1332.9390.02

The Bluetooth® word mark and logos are registered trademarks owned by Bluetooth SIG, Inc. and any use of such marks by Rohde&Schwarz is under license. MIPI® marks and logos are service marks owned by MIPI Alliance, Inc. and any use of such marks by Rohde & Schwarz is under license.

Designation	Type	Frequency range	Order No.
Extended power range for ports 1 to 4 (R&S®ZNBT26)	R&S®ZNBT26-B21	100 kHz to 26.5 GHz	1332.9348.34
Extended power range for ports 5 to 8 (R&S®ZNBT26)	R&S®ZNBT26-B22	100 kHz to 26.5 GHz	1332.9354.34
Extended power range for ports 9 to 12 (R&S®ZNBT26) ⁴⁾	R&S®ZNBT26-B23	100 kHz to 26.5 GHz	1332.9360.34
Extended power range for ports 13 to 16 (R&S®ZNBT26) ⁴⁾	R&S®ZNBT26-B24	100 kHz to 26.5 GHz	1332.9377.34
Extended power range for ports 17 to 20 (R&S®ZNBT26) ⁴⁾	R&S®ZNBT26-B25	100 kHz to 26.5 GHz	1332.9383.34
Extended power range for ports 21 to 24 (R&S®ZNBT26) ⁴⁾	R&S®ZNBT26-B26	100 kHz to 26.5 GHz	1332.9390.34
Extended power range for ports 1 to 4 (R&S®ZNBT40)	R&S®ZNBT40-B21	100 kHz to 40 GHz	1332.9348.44
Extended power range for ports 5 to 8 (R&S®ZNBT40)	R&S®ZNBT40-B22	100 kHz to 40 GHz	1332.9354.44
Extended power range for ports 9 to 12 (R&S®ZNBT40) ⁴⁾	R&S®ZNBT40-B23	100 kHz to 40 GHz	1332.9360.44
Extended power range for ports 13 to 16 (R&S®ZNBT40) ⁴⁾	R&S®ZNBT40-B24	100 kHz to 40 GHz	1332.9377.44
Extended power range for ports 17 to 20 (R&S®ZNBT40) ⁴⁾	R&S®ZNBT40-B25	100 kHz to 40 GHz	1332.9383.44
Extended power range for ports 21 to 24 (R&S®ZNBT40) ⁴⁾	R&S®ZNBT40-B26	100 kHz to 40 GHz	1332.9390.44
Precision frequency reference	R&S®ZNBT-B4		1332.9477.02
DC inputs	R&S®ZNBT-B81		1332.9502.02
GPIO interface	R&S®ZNBT-B10		1332.9483.02
Device control	R&S®ZNBT-B12		1332.9490.02
External handler I/O interface	R&S®ZNBT-Z14		1326.6640.05
External RFFE GPIO interface (MIPI®) ⁸⁾	R&S®ZN-Z15		1325.5905.02
External RFFE GPIO interface (MIPI®), including voltage and current measurements ⁹⁾	R&S®ZN-Z15		1325.5905.03
Additional interface cable for R&S®ZN-Z15 RFFE GPIO interface (including adapters)	R&S®ZN-Z25		1334.3424.02
Software options (firmware)			
Time domain analysis (TDR)	R&S®ZNBT-K2		1318.8425.02
Distance to fault (DTF) measurement	R&S®ZNBT-K3		1350.5063.02
Extended time domain analysis with eye diagram	R&S®ZNBT-K20		1319.4400.02
Frequency conversion ⁹⁾	R&S®ZNBT-K4		1318.8431.02
Intermodulation measurements ¹⁰⁾	R&S®ZNBT-K14		1318.8448.02
10 MHz receiver bandwidth	R&S®ZNBT-K17		1318.8454.02
1 mHz frequency resolution	R&S®ZNBT-K19		1319.4000.02
Accessories			
Calibration kits (manual calibration)			
Calibration kit, N, 50 Ω	R&S®ZV-Z270	0 Hz to 18 GHz	5011.6536.02
Calibration kit, 3.5 mm	R&S®ZN-Z235	0 Hz to 26.5 GHz	1336.8500.02
Calibration kit, 2.92mm, 50 Ω	R&S®ZN-Z229	0 Hz to 40 GHz	1336.7004.02
Calibration kit, N (m)	R&S®ZN-Z170	0 Hz to 18 GHz	1328.8163.02
Calibration kit, N (f)	R&S®ZN-Z170	0 Hz to 18 GHz	1328.8163.03
Calibration kit, 3.5 mm (m)	R&S®ZN-Z135	0 Hz to 26.5 GHz	1328.8157.02
Calibration kit, 3.5 mm (f)	R&S®ZN-Z135	0 Hz to 26.5 GHz	1328.8157.03
Calibration kit, 2.92mm (m), 50 Ω	R&S®ZN-Z129	0 Hz to 40 GHz	1328.8140.02
Calibration kit, 2.92mm(f), 50 Ω	R&S®ZN-Z129	0 Hz to 40 GHz	1328.8140.03
Calibration units (automatic calibration)			
Calibration unit, 4 ports, 3.5 mm (f)	R&S®ZN-Z51	100 kHz to 8.5 GHz	1319.5507.34
Calibration unit, 2 ports, 3.5 mm (f)	R&S®ZN-Z51	100 kHz to 8.5 GHz	1319.5507.32
Calibration unit, 4 ports, N (f) ¹¹⁾	R&S®ZN-Z51	100 kHz to 8.5 GHz	1319.5507.74
Calibration unit, 2 ports, N (f) ¹¹⁾	R&S®ZN-Z51	100 kHz to 8.5 GHz	1319.5507.72
Calibration unit, 2 ports, N (f)	R&S®ZN-Z151	300 kHz to 8.5 GHz	1317.9134.73

Designation	Type	Frequency range	Order No.
Calibration unit, 2 ports, N (f)	R&S®ZN-Z151	100 kHz to 8.5 GHz	1317.9134.72
Calibration unit, 6 ports, SMA (f)	R&S®ZN-Z152	100 kHz to 8.5 GHz	1319.6003.36
Calibration unit, 4 ports, SMA (f)	R&S®ZN-Z153	100 kHz to 8.5 GHz	1319.6178.34
Calibration unit, 6 ports, SMA (f)	R&S®ZN-Z154	100 kHz to 8.5 GHz	1319.5120.02
Additional ports 7 to 12, SMA (f)	R&S®ZNZ154-B22	100 kHz to 8.5 GHz	1319.5136.22
Additional ports 13 to 18, SMA (f)	R&S®ZNZ154-B32	100 kHz to 8.5 GHz	1319.5136.32
Additional ports 19 to 24, SMA (f)	R&S®ZNZ154-B42	100 kHz to 8.5 GHz	1319.5136.42
Calibration unit, 4 ports, 3.5 mm (f)	R&S®ZN-Z52	100 kHz to 26.5 GHz	1335.6991.30
Calibration unit, 2 ports, 2,92 mm (f)	R&S®ZN-Z54	9 kHz to 40 GHz	1335.7117.92
Torque wrench, 19 mm width, 0.9 Nm	R&S®ZN-ZTW		1328.8534.19
Torque wrench, 8 mm width, 0.9 Nm	R&S®ZN-ZTW		1328.8534.35
Torque wrench, 20 mm width, 1.5 Nm	R&S®ZN-ZTW		1328.8534.71
Test cables			
N (m)/N (m), 50 Ω, length: 0.6 m/1 m	R&S®ZV-Z91	0 Hz to 18 GHz	1301.7572.25/38
N (m)/N (m), 50 Ω, length: 0.6 m/0.9 m	R&S®ZV-Z191	0 Hz to 18 GHz	1306.4507.24/36
N (m)/3.5 mm (m), 50 Ω, length: 0.6 m/1 m	R&S®ZV-Z92	0 Hz to 18 GHz	1301.7589.25/38
N (m)/3.5 mm (m), 50 Ω, length: 0.6 m/0.9 m	R&S®ZV-Z192	0 Hz to 18 GHz	1306.4513.24/36
Hardware add-ons			
19" rackmount kit	R&S®ZZA-KN5		1175.3040.00
USB-to-IEC/IEEE adapter	R&S®ZVAB-B44		1302.5544.02
Additional removable hard disk, for LPW10	R&S®ZNBT-B19		1332.9283.10
Additional removable hard disk, for LPW11	R&S®ZNBT-B19		1332.9283.11
Simulation			
Licence dongle	R&S®ZNPC		1325.6601.02
Simulation for R&S®ZNB/ZNBT/ZNC/ZND	R&S®ZNXSIM-K1		1334.4066.02
TDR for VNA simulation	R&S®ZNXSIM-K22		1338.1632.02

¹⁾ External monitor, mouse and keyboard or external touchscreen required for manual operation.

²⁾ R&S®ZNBT8 only.

³⁾ Requires corresponding port extension option (R&S®ZNBT8-B1xx).

⁴⁾ Requires corresponding port extension option (either R&S®ZNBT8-B1xx, R&S®ZNBT8-B5xx or R&S®ZNBTxxB1xx).

⁵⁾ Extended dynamic range for the first four ports. Add-on option for R&S®ZNBT8 base unit.

⁶⁾ Cannot be combined with R&S®ZNBT8-B3xx options.

⁷⁾ Requires lower-numbered port extension options (either R&S®ZNBT8-B1xx or R&S®ZNBT8-B5xx).

⁸⁾ Includes one R&S®ZN-Z25 interface cable including adapters.

⁹⁾ Requires R&S®ZVAB-B44 to control external generators via IEC/IEEE bus. Second internal source is included with R&S®ZNBT8-B112/R&S®ZNBT20B112.

¹⁰⁾ Requires R&S®ZNBT-K4.

¹¹⁾ Can also be configured with other connector systems.

Warranty		
Base unit		three years
All other items		one year
Options		
Extended warranty, one year	R&S®WE1	
Extended warranty, two years	R&S®WE2	Please contact your local Rohde & Schwarz sales office.
Extended warranty with calibration coverage, one year	R&S®CW1	
Extended warranty with calibration coverage, two years	R&S®CW2	

Rear view of the R&S®ZNB20



Service that adds value

- ▶ Worldwide
- ▶ Local und personalized
- ▶ Customized and flexible
- ▶ Uncompromising quality
- ▶ Long-term dependability

Rohde & Schwarz

The Rohde&Schwarz electronics group offers innovative solutions in the following business fields: test and measurement, broadcast and media, secure communications, cybersecurity, monitoring and network testing. Founded more than 80 years ago, the independent company which is headquartered in Munich, Germany, has an extensive sales and service network with locations in more than 70 countries.

www.rohde-schwarz.com

Sustainable product design

- ▶ Environmental compatibility and eco-footprint
- ▶ Energy efficiency and low emissions
- ▶ Longevity and optimized total cost of ownership

Certified Quality Management

ISO 9001

Certified Environmental Management

ISO 14001

Rohde & Schwarz training

www.training.rohde-schwarz.com

Rohde & Schwarz customer support

www.rohde-schwarz.com/support

